

# CRYSTAL

## Crystal Pressure Fittings CPF

**Common Specifications** (applies to all CPF fittings in this datasheet)

### DESCRIPTION

CPF is an improved cone type fitting system that adds a unique o-ring sealing system which permits leak free connections without tools. CPF fittings can be directly connected to 1/4" medium pressure cone type fittings from other manufacturers\*, provided that wrenches are used to complete the connection. The fittings of the CPF system have been designed and tested to comply with ASME B31.3-2008, Chapter IX: High Pressure Piping.

\* HiP: 1/4" Female and Male Medium Pressure (LF4 & LM4 series)  
Autoclave Engineers: 1/4" Female and Male Medium Pressure (SF250CX series)

### PERFORMANCE

Maximum Allowable Working Pressure (MAWP): **10000 PSI / 700 bar / 70 MPa**  
Finger-tight: **-20 to 50°C**  
Wrench-tight: **-40 to 150°C**  
Minimum Hose Bend Radius: **1.0" (25mm)**

*Most fittings throughout this document meet the MAWP specification of 10000 PSI/700 bar/70 MPa. Exceptions are labeled with either **5** to indicate a fitting rated to 5000 PSI, or **15** to indicate a fitting rated to 15000 PSI.*

### CONSTRUCTION

Thread Type: **7/16-20 UNF 2B**  
Cone Angle: **60°, nominal**  
Fittings: **High Strength 316 Stainless Steel**  
Hose: **Polyamide core with urethane jacket**  
External Hose Diameter: **0.235" (6 mm)**  
Internal Hose Diameter: **0.08" (2 mm)**  
Hose Weight: **0.0179 lbs/ft (26.6 g/m)**  
CPF Female O-rings: **AS568A-012, Viton® 90**  
O-ring Lubricant: **Molykote® 55**

*Hose is not compatible with dioctyl sebacate fluid.*

### RECOMMENDATIONS

Thread Lubricant: **Use a process compatible fluid**  
Wrench Torque: **100–140 in-lbs (11.3–15.8 Nm)**



### Quick Links

CPF Fittings	<b>2</b>	Tube Fitting	<b>11</b>
NPT Fittings	<b>5</b>	AN4 Fittings	<b>11</b>
NPT Fitting Kits	<b>7</b>	Pump Adapters	<b>12</b>
BSP Fittings	<b>8</b>	Pump Fitting Kits	<b>12</b>
BSP Fitting Kits	<b>8</b>	GaugeCalXP Fitting Kit	<b>12</b>
M20 Fittings	<b>9</b>	ComboPump Fitting Kits	<b>12</b>
Transmitter Fittings	<b>10</b>	Non-Crystal MP Adapters	<b>13</b>

### Note Regarding CPF Hose (MPH-X)

Due to the wide variety of operating conditions it may be subject to, Crystal Engineering, as well as Distributors and Representatives of Crystal products, do not warrant that this hose is suitable for any specific use. This hose is not for use with compressed natural gas (CNG).

When used with gases, fuels (liquid or gas) and refrigerants, permeation (i.e., seepage) will occur from inside the hose. In enclosed or unventilated spaces this permeation may result in high concentrations of vapors which are potentially flammable, explosive or toxic.

Care must be taken to protect hoses from snagging, kinking, bending smaller than the minimum bend radius, and cutting. Any hose that has been damaged in any way should be removed from service and discarded immediately.

Autoclave Engineers Fluid Components is a division of Snap-tite, Inc.

HiP is High Pressure Equipment Company.

Molykote is a registered trademark of Dow Corning Corporation.

Viton is a registered trademark of DuPont Performance Elastomers.

Swagelok is a registered trademark of Swagelok Company.



Crystal Pressure Fittings Data Sheet

4895.C

Page 1 of 13

## CPF Fittings

### HOSES (10 000 PSI; FOS-4:1)

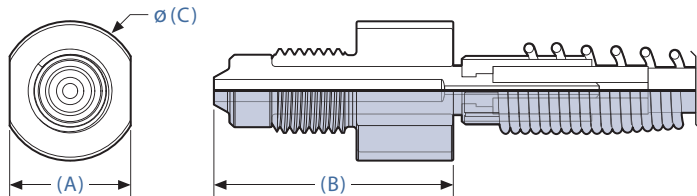

Option: Integral CPF Hose Reels are portable, with an internal friction brake and a locking mechanism to prevent unspooling. CPF Hose Reels are available for hose lengths from 10 to 50 meters. Hoses must be permanently factory-installed to the Reel using a double-bulkhead fitting. The reel connection is CPF female.

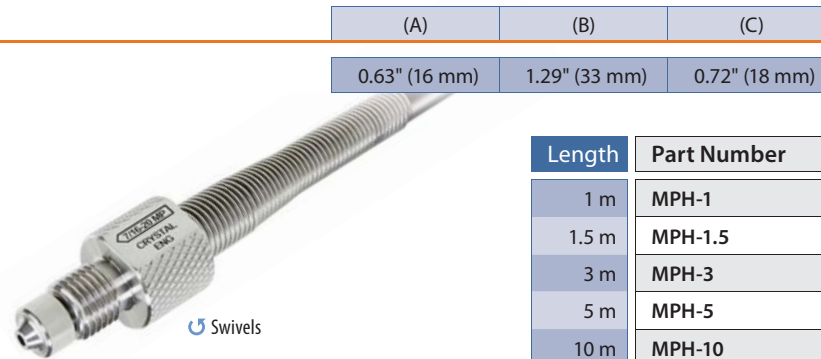

Swivels

(A)	(B)	(C)
0.63" (16 mm)	1.29" (33 mm)	0.72" (18 mm)

Length	Part Number
1 m	MPH-1
1.5 m	MPH-1.5
3 m	MPH-3
5 m	MPH-5
10 m	MPH-10
25 m	MPH-25
50 m	MPH-50
100 m	MPH-100

MPH-10-HR	*
MPH-25-HR	*
MPH-50-HR	*

Includes hose reel option \*

### HOSES (15 000 PSI; FOS-2.5:1)

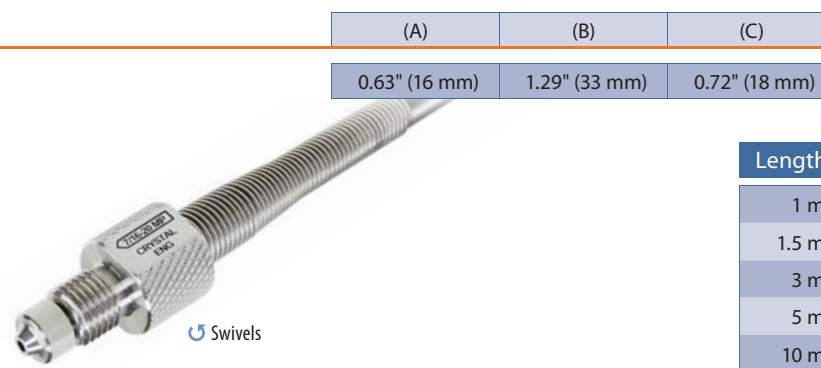
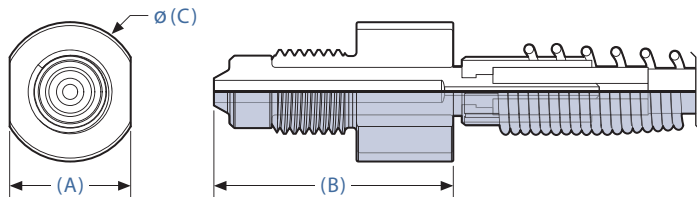

Swivels

(A)	(B)	(C)
0.63" (16 mm)	1.29" (33 mm)	0.72" (18 mm)

Length	Part Number
1 m	MPH15K-1
1.5 m	MPH15K-1.5
3 m	MPH15K-3
5 m	MPH15K-5
10 m	MPH15K-10
25 m	MPH15K-25
50 m	MPH15K-50
100 m	MPH15K-100

All CPF hoses are rated for hydraulic & pneumatic pressure to 10 000 PSI with a 4:1 Factor of Safety. Hoses bearing the MPH15K- label are rated for hydraulic pressure only, to 15 000 PSI with a 2.5:1 Factor of Safety (the fitting and hose are still marked MAWP 10 000PSI).

MPH15K-15.000 PSI (1000 bar) MAWP



## CPF Fittings

### MALE CONNECTOR

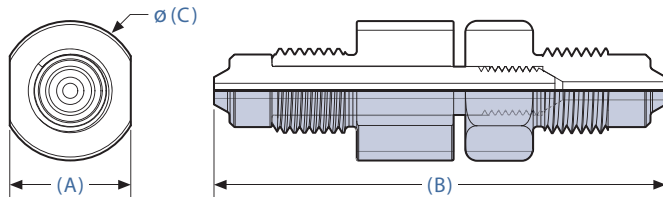

(A)	(B)	(C)	Part Number
0.63" (16 mm)	2.33" (59 mm)	0.72" (18 mm)	MPM-MPM

### UNION

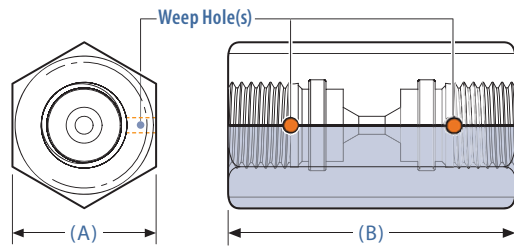

(A)	(B)	Part Number
0.75" (19 mm)	1.50" (38 mm)	MPF-MPF

### UNION TEE

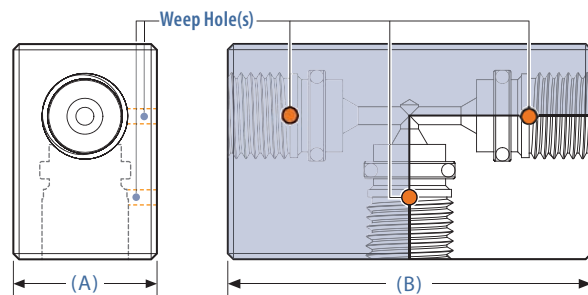

(A)	(B)	Part Number
0.75" (19 mm)	1.90" (48 mm)	MPF-MPFTU



## CPF Fittings

### BULKHEAD MOUNT

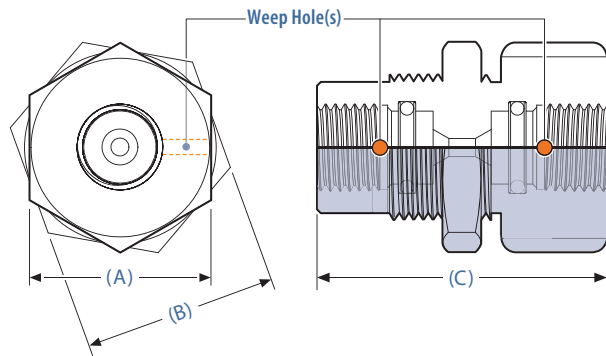

(A)	(B)	(C)	Part Number
0.938" (24 mm)	1.00" (26 mm)	1.50" (38 mm)	MPF-MPFBULK

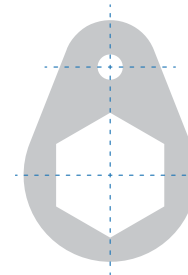

**Note:**  
Includes bulkhead retainer (Part # 4417).

### CAP

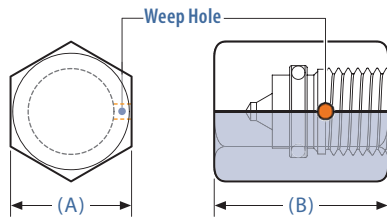

(A)	(B)	Part Number
0.63" (16 mm)	0.90" (23 mm)	MPF-CAP

### PLUG

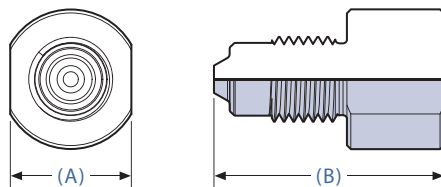

(A)	(B)	Part Number
0.63" (16 mm)	1.19" (30 mm)	MPM-PLUG



## NPT Fittings

### CPF MALE TO NPT MALE

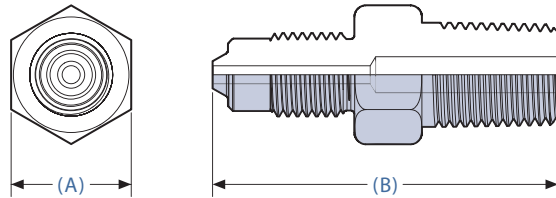

(A)	(B)	Part Number
0.63" (16 mm)	2.50" (64 mm)	<b>MPM-1/8MPT</b>
0.63" (16 mm)	1.80" (46 mm)	<b>MPM-1/4MPT</b>

### NPT MALE

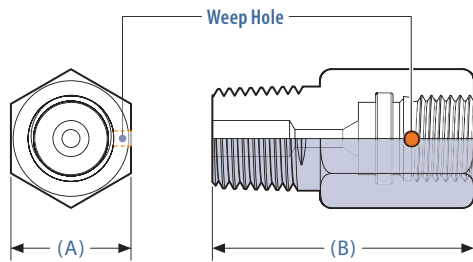

(A)	(B)	Part Number
0.63" (16 mm)	1.12" (28 mm)	<b>MPF-1/8MPT</b>
0.63" (16 mm)	1.36" (35 mm)	<b>MPF-1/4MPT</b>

### NPT FEMALE

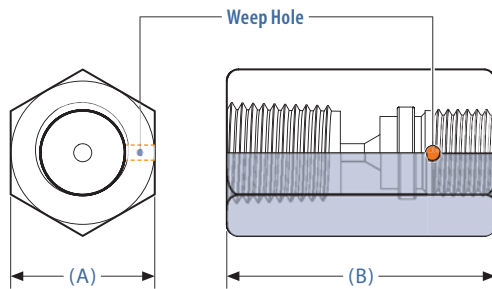

(A)	(B)	Part Number
0.75" (19 mm)	1.40" (36 mm)	<b>MPF-1/4FPT</b>



## NPT Fittings

### NPT QUICK TEST MALE

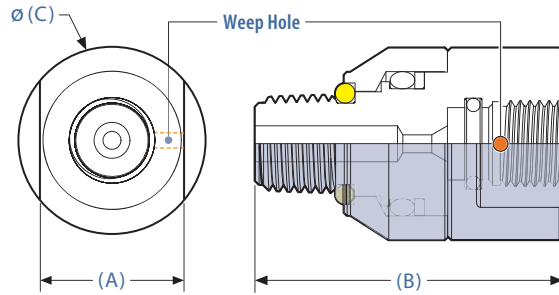

(A)	(B)	(C)	Part Number
0.63" (16 mm)	1.48" (38 mm)	1.00" (25 mm)	<b>MPF-1/8QTM</b> AS568A-109 Neoprene 70 Replacement O-ring
0.75" (19 mm)	1.60" (41 mm)	0.82" (21 mm)	<b>MPF-1/4QTM</b> AS568A-111 Neoprene 70 Replacement O-ring

### NPT QUICK TEST FEMALE

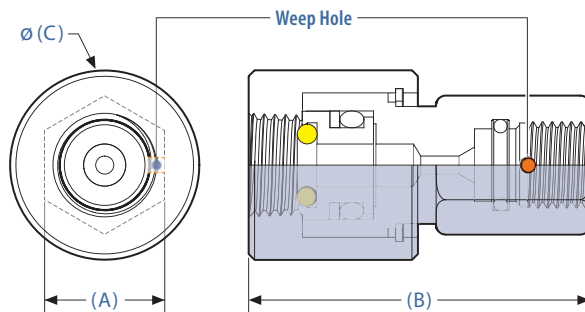

(A)	(B)	(C)	Part Number
0.63" (16 mm)	1.68" (38 mm)	0.85" (22 mm)	<b>MPF-1/8QTF</b> AS568A-105 Neoprene 70 Replacement O-ring
0.63" (16 mm)	1.78" (45 mm)	1.00" (25 mm)	<b>MPF-1/4QTF</b> AS568A-108 Neoprene 70 Replacement O-ring
0.63" (16 mm)	1.81" (46 mm)	1.37" (35 mm)	<b>MPF-1/2QTF</b> AS568A-112 Neoprene 70 Replacement O-ring

Fitting rated to 5000 PSI <sup>5</sup>

### 90° NPT MALE

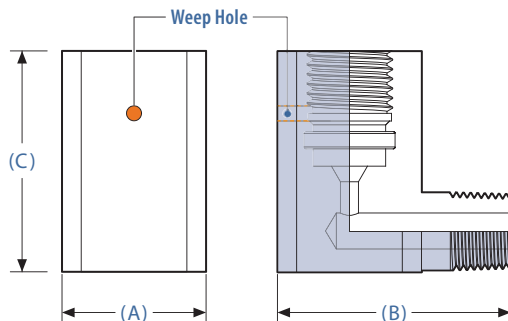

(Intended for use with ComboPump)

(A)	(B)	(C)	Part Number
0.75" (19 mm)	1.20" (31 mm)	1.15" (29 mm)	<b>MPF-1/8MPT90</b>



## NPT Fittings

### NPT MALE TO NPT QUICK TEST FEMALE

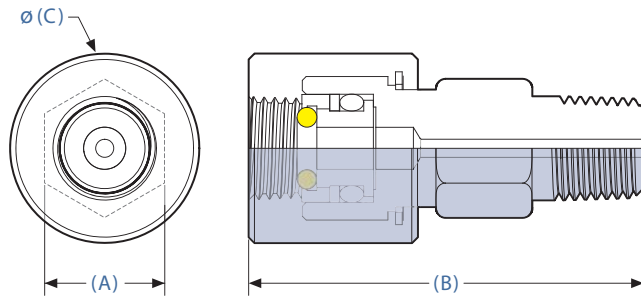

(1/8MPT fittings intended for use with ComboPump)  
(1/4MPT fittings intended for use with HydraulicPump)

(A)	(B)	(C)	Part Number
0.63" (16 mm)	1.90" (48 mm)	1.00" (25 mm)	<b>1/8MPT-1/4QTF</b> AS568A-108
Neoprene 70 Replacement O-ring			
0.63" (16 mm)	2.06" (52 mm)	1.00" (25 mm)	<b>1/4MPT-1/4QTF</b> AS568A-108
Neoprene 70 Replacement O-ring			

### NPT FITTING KITS



		Part Number
Complete NPT Hose and Fitting Kit	Includes: 1/8 NPT [Male (2), Male 90°, Male Quick Test, and Female Quick Test], 1/4 NPT [Male (2), Female, Male Quick Test, and Female Quick Test], 1/2 NPT [Female Quick Test], Tube [1/4 Male, 3/8 Male, and 1/2 Male], AN4 Male, Transmitter [1/4 Male and 5/16 Male], CPF Connectors [Male-Male, T-Union, Plug, and Cap (2)], Hose [1 meter], and Custom Carrying Case.	<b>4016</b>
Quick Test NPT Kit	Includes: MPF-1/8QTF, MPF-1/4QTF, and MPF-1/2QTF	<b>4013</b>



## BSP Fittings

### CPF MALE TO BSP MALE

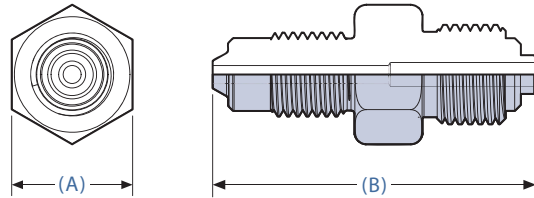

(A)	(B)	Part Number
0.63" (16 mm)	1.68" (43 mm)	<b>MPM-1/4BSPM</b>

### BSP FEMALE

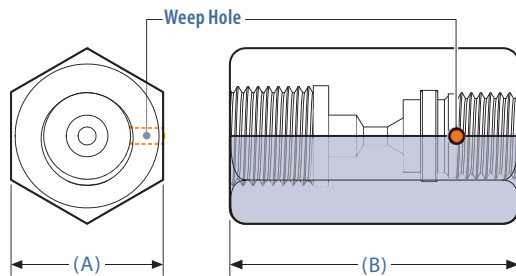

(A)	(B)	Part Number
0.79" (20 mm)	1.50" (38 mm)	<b>MPF-1/8BSPF</b>
0.79" (20 mm)	1.50" (38 mm)	<b>MPF-1/4BSPF</b>
0.98" (25 mm)	1.75" (45 mm)	<b>MPF-3/8BSPF</b>
1.18" (30 mm)	2.05" (52 mm)	<b>MPF-1/2BSPF</b>

### BSP FITTING KITS



#### Complete BSP Hose and Fitting Kit

Includes: BSP Female [1/8, 1/4 (2), 3/8, and 1/2], NPT [1/4 Quick Test Female and 1/8 Male (2)], Transmitter [1/4 Male and 5/16 Male], CPF Connectors [Male-Male, T-Union, Plug, and Cap (2)], Hose [1 meter], Custom Carrying Case.

Part Number

**4017**

#### BSP Test Kit

Includes: MPF-1/8BSPF, MPF-1/4BSPF, MPF-3/8BSPF, and MPF-1/2BSPF

**4015**





## M20 Fittings

### CPF MALE TO M20 MALE

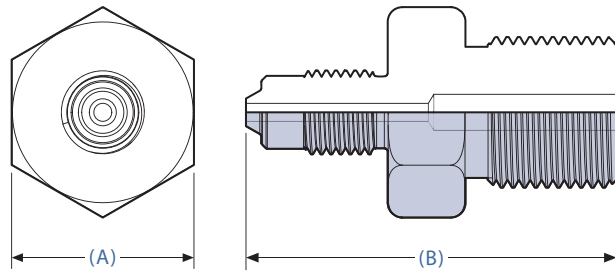

(A)	(B)	Part Number
0.95" (24 mm)	1.93" (49 mm)	MPM-M20X1.5M

### M20 FEMALE

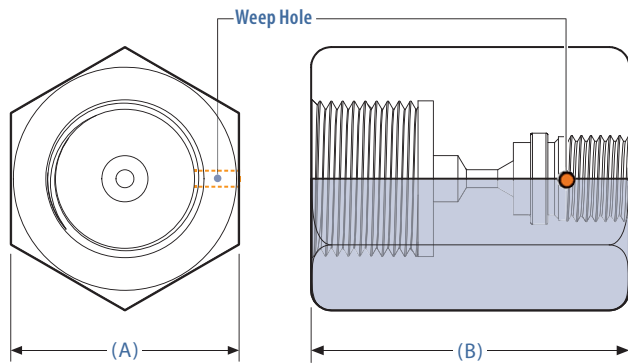

(A)	(B)	Part Number
1.18" (30 mm)	1.65" (42 mm)	MPF-M20X1.5F

### M20 QUICK TEST FEMALE

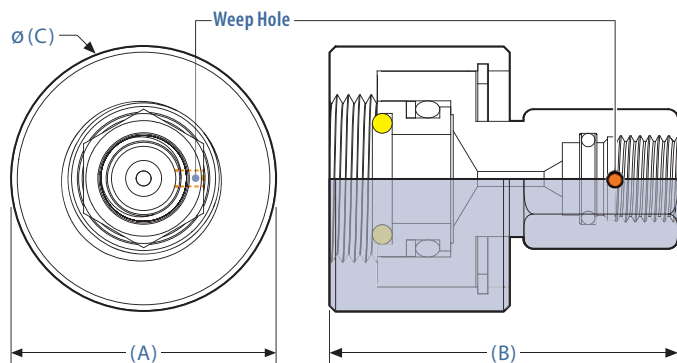

(A)	(B)	(C)	Part Number
0.63" (16 mm)	1.81" (46 mm)	1.375" (35 mm)	MPF-M20QTF
Neoprene 70 Replacement O-ring			AS568A-112

Fitting rated to 5000 PSI

Swivels



## Transmitter Fittings

### FOR FOXBORO, ROSEMOUNT, & YOKOGAWA

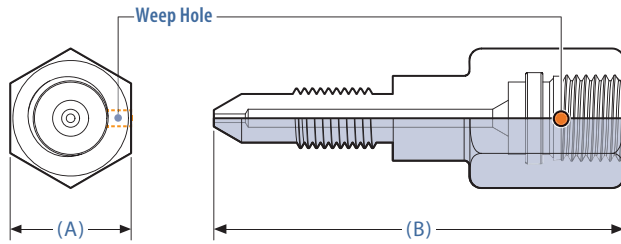

(A)	(B)	Part Number
0.63" (16 mm)	2.13" (54 mm)	MPF-5/16TRM <sup>5</sup>

### FOR HONEYWELL

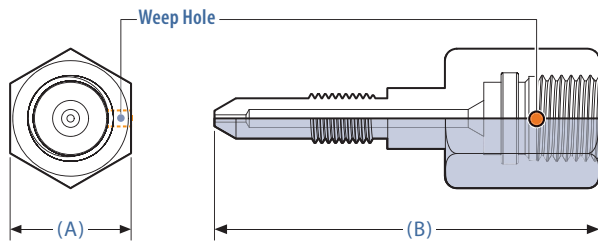

(A)	(B)	Part Number
1.18" (30 mm)	1.65" (42 mm)	MPF-1/4TRM <sup>5</sup>

Fittings rated to 5000 PSI <sup>5</sup>

## Tube Fitting

### TUBE MALE

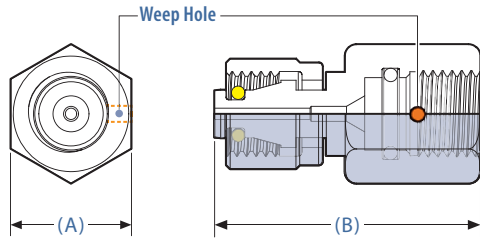

(A)	(B)	Part Number
0.63" (16 mm)	1.38" (35 mm)	<b>MPF-1/4TBM</b> VITON 90 Replacement O-ring AS568A-007
0.63" (16 mm)	1.50" (38 mm)	<b>MPF-3/8TBM</b> VITON 90 Replacement O-ring AS568A-010
0.63" (16 mm)	1.74" (44 mm)	<b>MPF-1/2TBM</b> VITON 90 Replacement O-ring AS568A-012

## AN4 Fittings

### AN4 MALE

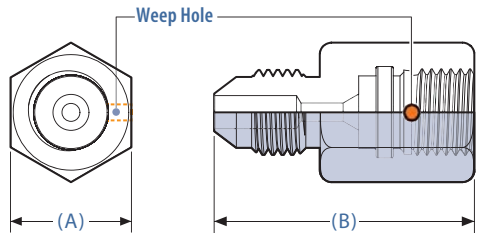

(A)	(B)	Part Number
0.63" (16 mm)	1.35" (34 mm)	<b>MPF-AN4M</b>

### AN4 UNION SWIVEL (NON CPF)

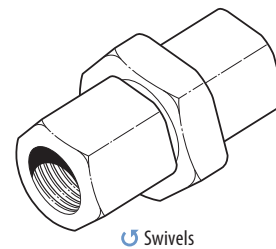
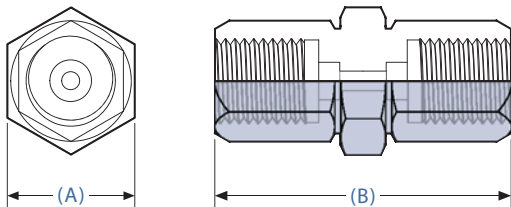

(A)	(B)	(C)	Part Number
0.56" (14 mm)	1.60" (41 mm)	0.69" (17 mm)	<b>4377</b>

Fittings rated to 5000 PSI



## Pump Adapters

### QUICK CONNECT NUT

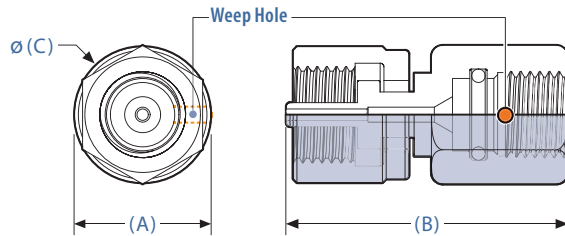

(A)	(B)	Part Number
0.63" (16 mm)	1.47" (37 mm)	<b>MPF-QCN</b>

### CPF FEMALE TO HYDROPUMP

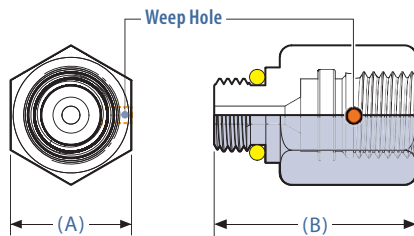

(A)	(B)	Part Number
0.63" (16 mm)	1.05" (27 mm)	<b>MPF-3/8SAEM</b>
VITON 90 Replacement O-ring		<b>AS568A-011</b>

Fittings rated to 5000 PSI

## Pump Fitting Kits

### GAUGEALXP FITTING KIT

		Part Number
CPF Upgrade Kit	Used to convert older GaugeCaXPs to use the CPF fitting system. Applies to serial number 649745 or greater. Includes: MPF-GC (2), MPF-1/4FPT (2), and MPM-MPM (2)	<b>4012</b>

### COMBOPUMP FITTING KITS

		Part Number
Connects to nVision, XP2i, and m1	Includes: MPF-1/4MPT, MPM-1/8MPT, MPF-1/8MPT90, and MPH-1	<b>4018</b>
Connects to 30 Series Calibrator	Includes: MPF-1/4MPT, MPF-1/8MPT, MPF-1/8MPT90, MPM-1/8MPT, and MPH-1	<b>4020</b>



## Non-Crystal MP Adapters

### MEDIUM PRESSURE MALE TO NPT FEMALE

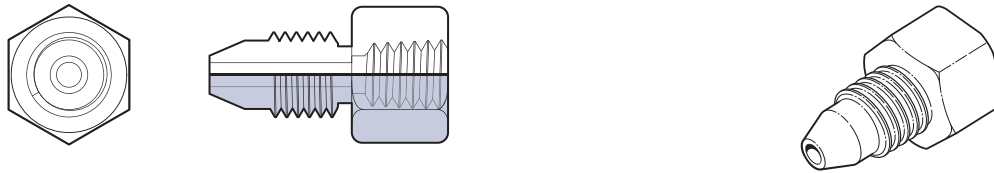

Size	Product Marking	Part Number
1/8 NPT	2NF04M15	4497 <sup>15</sup>
1/4 NPT	4NF04M15	4498 <sup>15</sup>
3/8 NPT	6NF04M15	4499 <sup>15</sup>
1/2 NPT	8NF04M15	4500 <sup>15</sup>

### MEDIUM PRESSURE MALE TO NPT MALE

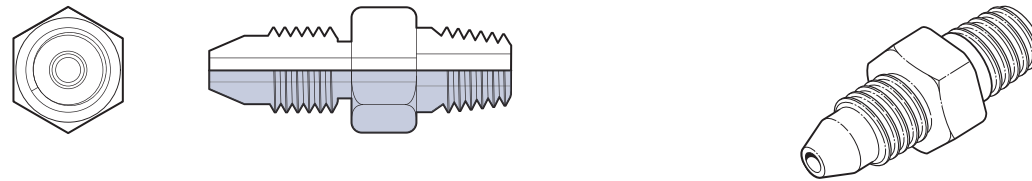

Size	Product Marking	Part Number
1/4 NPT	4N04M15	4698 <sup>15</sup>
3/8 NPT	6N04M15	4492 <sup>15</sup>
1/2 NPT	8N04M15	4493 <sup>15</sup>

### MEDIUM PRESSURE FEMALE TO NPT FEMALE

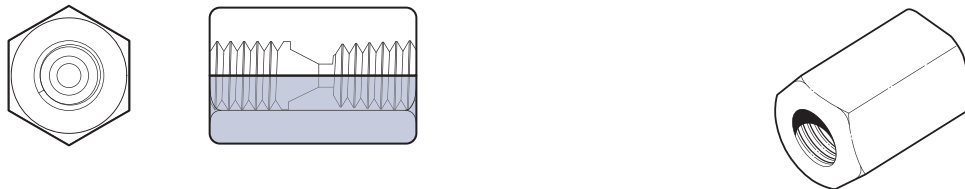

Size	Product Marking	Part Number
1/8 NPT	2NF04MF15	4501 <sup>15</sup>
1/4 NPT	4NF04MF15	4715 <sup>15</sup>
3/8 NPT	6NF04MF15	4502 <sup>15</sup>
1/2 NPT	8NF04MF15	4503 <sup>15</sup>

### MEDIUM PRESSURE FEMALE TO NPT MALE

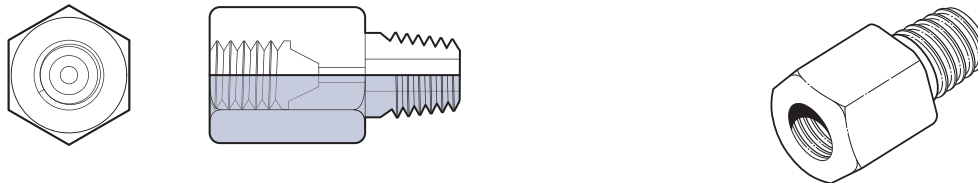

Size	Product Marking	Part Number
1/4 NPT	4N04MF15	4714 <sup>15</sup>
3/8 NPT	6N04MF15	4494 <sup>15</sup>
1/2 NPT	8N04MF15	4495 <sup>15</sup>
3/4 NPT	12N04MF10	4496 <sup>15</sup>

Fittings rated to 15000 PSI <sup>15</sup>